GL0013K

INSTALLATION GUIDELINES FOR BIODISC UNITS BC & NC



Klargester Environmental	
College Road North, Aston Clinton, Aylesbury, Buckinghamshire, HP22 5EW	
Tel: +44 (0) 1296 633033	Fax: +44 (0) 1296 633001
Website: www.klargester.co.uk	Email: uksales@klargestere.co.uk

Issue	Description	Date
04	CC 522	October 2007

HEALTH AND SAFETY

These warnings are provided in the interest of safety. You must read them carefully before installing or using the equipment.

It is important that this document is retained with the equipment for future reference. Should the equipment be transferred to a new owner, always ensure that all relevant documents are supplied in order that the new owner can be acquainted with the functioning of the equipment and the relevant warnings.

Installation should only be carried out by a suitably experienced contractor, following the Guide-Lines supplied with the equipment.

We recommend the use of a dust mask and gloves when cutting GRP components.

Electrical work should be carried out by a qualified electrician.

Sewage and sewage effluent can carry micro-organisms harmful to human health. Any person carrying out maintenance on the equipment should wear suitable protective clothing, including gloves. Good hygiene practice should also be observed.

Covers must be kept locked.

Observe all hazard labels and take appropriate action to avoid exposure to the risks indicated.

The correct ongoing maintenance is essential for the proper operation of the equipment. Klargester offer a range of maintenance contracts, details on request.

Should you wish to inspect the operation of the equipment, please observe all necessary precautions, including those listed below, which apply to maintenance procedures.

BioDisc units contain rotating machinery and associated drive chains or belts.

Ensure that you are familiar with the safe working areas and accesses.

Ensure that the working area is adequately lit.

The power supply to the equipment must be isolated at the control panel(s) before lifting the covers. Where a specific maintenance procedure requires the equipment to be running with the covers off, all care must be taken to avoid contact with moving parts and electrical components or conductors. Drive guards must be replaced and secured if removed during maintenance.

Once power has been isolated, the control panel must be kept locked shut to avoid accidental re-connection whilst work or inspection is being carried out.

Use only the designated access walkways. Do not walk on the cover or deep well safety mesh(s). Desludge port covers, where fitted, must be replaced if removed.

Take care to maintain correct posture, particularly when lifting. Use appropriate lifting equipment when necessary. Keep proper footing and balance at all times. Avoid any sharp edges.

Desludging should be carried out by a contractor holding the relevant permits to transport and dispose of sewage sludge. The contractor must refer to the desludge instructions in the Operating Manual, a copy of which is fastened under the covers.

BioDisc is the registered trademark of Klargester Environmental

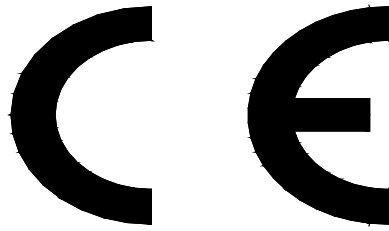

ETS Ltd

**Trading as: Klargester Environmental
College Road North**

Aston Clinton

**Aylesbury
Buckinghamshire
HP22 5EW**







United Kingdom

07

EN 12566-3

BA - BF BioDisc

Hydraulic daily load:	1.2m³/day - 10m³/day
Material:	GRP Glass Reinforced Plastic
Watertightness (water test):	Pass
Structural Calculation:	Pass
Treatment efficiency:	COD: 89%
	BOD5: 96%
	SS: 95%
	Total P: 48%
	NH4: 89%
	Total N: 46%
Electrical consumption:	1.3 kWh/d - 3.1 kWh/d
Sludge production:	0.21 litres per person per day

CONTENTS	Page
HEALTH AND SAFETY	2
1 Introduction	5
1.2 Handling & Storage	5
1.3 Site Planning	5
2 Installation - General	6
2.2 BioDisc Installation	7
2.3 Wet Site	8
2.4 Dry Site	8
3 Control Panel Installation	9
3.1 General Installation	9
3.2 Mounting Frame Installation (where applicable)	9
3.3 Installation of Control Panel	9
3.4 Installation of Integral Discharge Pump (where applicable) 	10
3.5 Installation of Sludge Return Pump (where applicable) 	10
3.6 Installation of Chemical Dosing System (where applicable) 	11
3.7 Installation of Loss of Rotation Alarm (where applicable) 	11
3.8 Installation of High Level Alarm (where applicable) 	11
3.9 Installation of Beacon (where applicable) 	11
3.10 Completing the Installation	12
4 Ancillary Equipment	12
5 Start Up	12

1 Introduction

1.1.1 These Guidelines represent Best Practice for the installation of these Klargester BioDisc Units. Many years of specialist experience has led to the successful installation of thousands of BioDisc units. It must be noted, however, that these Guidelines are necessarily of a general nature. It is the responsibility of others to verify that they are appropriate for the specific ground conditions and in-service loads of each installation. Similarly, any information or advice given by employees or agents of Klargester regarding the design of an installation must be verified by a qualified specialist (e.g. civil engineering consultant).

1.2 Handling & Storage

1.2.1 Care must be taken to ensure that the unit is not damaged during delivery and handling on site.

1.2.2 The design requirements of Klargester products will frequently mean that the centre of gravity of the unit is “offset”. Care must therefore be taken to ensure that the unit is stable when lifting. Rainwater may collect also inside units, particularly if they have been stored on site prior to installation, adding weight and increasing instability. Check units before lifting and pump out any excess water.

1.2.3 When lifting the unit, use webbing slings of a suitable specification, which must be attached to the designated lifting points.

1.2.4 Do not use chains.

1.2.5 Lifting equipment should be selected by taking into account the unit weight, length and the distance of lift required on site.

1.2.6 Klargester Environmental accepts no responsibility for the selection of lifting equipment.

1.2.7 Whenever Klargester BioDiscs are stored or moved on site, ensure that the storage location is free of rock, debris and any sharp objects which may damage the unit. The BioDisc must be placed on ground which is flat and level to evenly support the base of the unit.

1.3 Site Planning

1.3.1 The following points should be considered before installation of the equipment:

1.3.2 The discharge must have the consent of the relevant Environmental Regulator.

1.3.3 The installation should have Planning and Building Control approval.

1.3.4 Ground conditions and water table level should be assessed. If the water table will be above the base of the unit at any time of the year, adequate concrete backfill must be provided to avoid flotation. In poorly draining ground, consideration should also be given to the likelihood of flotation due to surface water collecting in the backfill. It should be borne in mind that the inlet drain trench will act as a land drain, directing surface water to the backfill around the unit.

1.3.5 If discharge is to a soakaway, a porosity test should be carried out in accordance with BS 6297 to assist in assessing sub-soil drainage and designing the sub-surface irrigation system.

1.3.6 The BioDisc system must be installed at a level which will allow connection to the incoming drain and a free discharge at the system outlet.

1.3.7 The drainage system connecting to the BioDisc must be adequately vented in accordance with the Building Regulations. The head of the drainage system should be connected to a stack pipe, open at high level, so as to draw foul air from the system and sited with consideration to prevailing wind direction. Tile vents & Air admittance valves should not be used as the sole drainage ventilation facility, but if this cannot be avoided, the BioDisc should be independently ventilated. All inspection points within the drain system should be sealed so as to enable ventilation at high level.

1.3.8 The unit should be installed so that the bottom lip of the cover is 65mm above local ground level. If the unit has to be recessed, measures must be taken to ensure that it cannot be flooded by surface water run-off.

1.3.9 There must be at least 1 metre of clear, level ground all around the unit to allow for routine servicing.

1.3.10 The unit should be installed as far as possible from any habitable building. Many Local Authorities will insist on a minimum distance of 15 metres.

GL0013K – Installation Guidelines for BioDisc BC & NC

- 1.3.11 Adequate access must be provided for routine de-sludging and maintenance. Vehicles should not be permitted within a distance equal to the depth of the unit, unless suitable structural protection is provided to the installation.
- 1.3.12 BioDisc covers are not suitable for walking on. Where necessary the BioDisc should be fenced off or otherwise protected. Maintenance access must be maintained as above.
- 1.3.13 An adequate electrical supply must be provided, complying with current electrical regulations. The electrical details in Table 1 will enable selection of suitable cable and current overload protection, taking into account the distance from the power source to the control panel and any other relevant factors. In most cases steel wire armoured (SWA) cable, minimum 1.5sq mm will be suitable, selection of the cable is the responsibility of the installing electrician.

		Full Load Current (Amps)	
		BC	NC
Motor	240 volt single phase	1.00	1.00
	415 volt three phase	0.34	0.34
Integral discharge pump	240 volt single phase only	2.2	N/A
Sludge return pump	240 volt single phase only	N/A	2.2

Table 1 : Electrical Supply Data

- 1.3.14 Pump stations or any other associated equipment should have a separate power supply.
- 1.3.15 Proximity to a mains water hosepipe connection point is recommended, for maintenance purposes. Such a supply should be connected in accordance with water bylaws and regulations. **Never leave a hose connected and immersed in sewage.**
- 1.3.16 Installation should only be carried out by suitably qualified and experienced contractors in accordance with the Health and Safety at Work Act. Electrical work should be carried out by a qualified electrician, working to the latest edition of IEE.

2 Installation - General

- 2.1.1 When units are installed in unstable ground conditions where movement of the surrounding material and/or unit may occur, the connecting pipework should be designed to minimise the risk of damage from differential movement of the unit(s) and/or surrounding material.
- 2.1.2 In situations where the excavation will not maintain a vertical wall, it will be necessary to support side walls of the excavation (E.g. with suitable trench sheets and bracing systems) to maintain a vertical wall from the bottom to the top of the excavation. DO NOT completely remove the shoring system until after the backfilling is complete, but before the concrete fully hardens.
- 2.1.3 In areas where the water table is above the bottom of the excavation and/or the excavation is liable to flood, the excavation should be de-watered, using suitable pumping equipment, until the installation is complete. In such conditions it may be advisable to line the excavation with polythene sheeting, to prevent cement being washed out of the concrete surround/base.
- 2.1.4 During installation, care must be taken to ensure that the body of the unit is uniformly supported so that point loads through the unit are avoided.
- 2.1.5 A water supply must be available on site to enable the unit to be ballasted during backfilling.
- 2.1.6 Concrete Specification below is a *general* specification. It is not a site-specific installation design.
- 2.1.7 **A Dry Site** is defined as one where groundwater lies below the base of the excavation at all times and the subsoil is free-draining. If in any doubt, assume “Wet Site” conditions.
- 2.1.8 **A Wet Site** is defined as one where the subsoil is not free draining (e.g. clay) or ground water lies above the base of the excavation at any time.

GENERAL CONCRETE SPECIFICATION IN ACCORDANCE WITH BS EN 206-1 (BS 8500-1)	
TYPE OF MIX	(DC) DESIGN
PERMITTED TYPE OF CEMENT	BS 12 (OPC): BS 12 (RHPC): BS 4027 (SRPC)
PERMITTED TYPE OF AGGREGATE (coarse & fine)	BS 882
NOMINAL MAXIMUM SIZE OF AGGREGATE	20 mm
GRADES: C25 /30 C25 /30 C16 /20	REINFORCED & ABOVE GROUND WITH HOLDING DOWN BOLTS REINFORCED (EG. FOR HIGH WATER TABLE) UNREINFORCED (NORMAL CONDITIONS)
MINIMUM CEMENT CONTENT	C30 C20 270 - 280 Kg/M ³ 220 - 230 Kg/M ³
SLUMP CLASS	S1 (25mm)
RATE OF SAMPLING	READY MIX CONCRETE SHOULD BE SUPPLIED COMPLETE WITH APPROPRIATE DELIVERY TICKET IN ACCORDANCE WITH BS EN 12350-1
NOTE: STANDARD MIXES SHOULD NOT BE USED WHERE SULPHATES OR OTHER AGGRESSIVE CHEMICALS EXIST IN GROUND WATER	

2.1.9 **Note: Units with 1100mm deep inlet invert must always be installed according to the guidelines for wet sites, irrespective of site conditions.**

2.2 BioDisc Installation

- 2.2.1 Remove the package tied to the outside of the unit. This contains a copy of the Installation Guidelines and a cover key.
- 2.2.2 Excavate a hole of sufficient length and width to accommodate the unit and a minimum of 150mm concrete surround and to a depth which allows for the burial depth of the unit plus a minimum 150mm thick concrete base. Note that the base must be at least 50mm wider than each of the steel fixing plates at the base of the unit.
- 2.2.3 Construct a suitable concrete base slab, a minimum of 150 mm thick, appropriate to site conditions. In wet or unstable ground conditions it may be necessary to lay a hard-core sub-base (see notes 3.3 & 4.3). Ensure that the slab is flat and level. Allow the slab to set sufficiently to support the installed load, but not so much as to prevent subsequent backfill bonding fully to the base.
- 2.2.4 Ensure that the slab is free of any stones or other material which could damage the unit. Lower the unit onto the slab using suitable webbing slings and lifting equipment.
- 2.2.5 Remove the covers by undoing the locks and folding the covers before lifting them off.
- 2.2.6 Remove the Control Panel and Owners Pack from the inside the unit.
- 2.2.7 Check that the inlet and outlet orientation is correct and that the unit is level. The unit must be level from side to side within 5mm at the top flange. If necessary, lift the unit off the base and apply further concrete as needed to level up.
- 2.2.8 It is essential that the flange levels are checked regularly throughout the installation process. Should the unit become out of level, immediate remedial action is advised, to maintain the unit within the levels stated in section 2.2.7.
- 2.2.9 Pour water into the primary (inlet) chamber and the final (outlet) chamber, to a depth of 1 metre. As backfilling proceeds maintain the water level 200-250mm above the backfill level, but do not attempt to fill the unit with water above the outlet level.
- 2.2.10 Place concrete backfill to approximately 1 metre above the unit base, ensuring good compaction to avoid voids. **Do not use vibrating pokers.** Keep the concrete at an even level all round the unit, compacting in layers. Note that the steel plates at the base of the unit are provided to anchor the unit into the concrete backfill and prevent flotation due to groundwater after installation; the concrete backfill must exceed the plate length by least 50mm.
- 2.2.11 Continue backfilling according to site conditions (see section 2.1.7 & 2.1.8).

2.2.12 **Note: 1100mm inlet invert depth units must be installed as for Wet Site.**

2.3 Wet Site

- 2.3.1 Raise the water level inside the unit to just below the outlet.
- 2.3.2 Continue backfilling with concrete up to the level of the outlet.

2.4 Dry Site

- 2.4.1 Raise the water level inside the unit to just below the outlet.
- 2.4.2 Continue backfilling to the outlet level with concrete, pea shingle (3-18mm), or similar non-cohesive, non-compressible free-flowing granular material. **Do not use sand.**

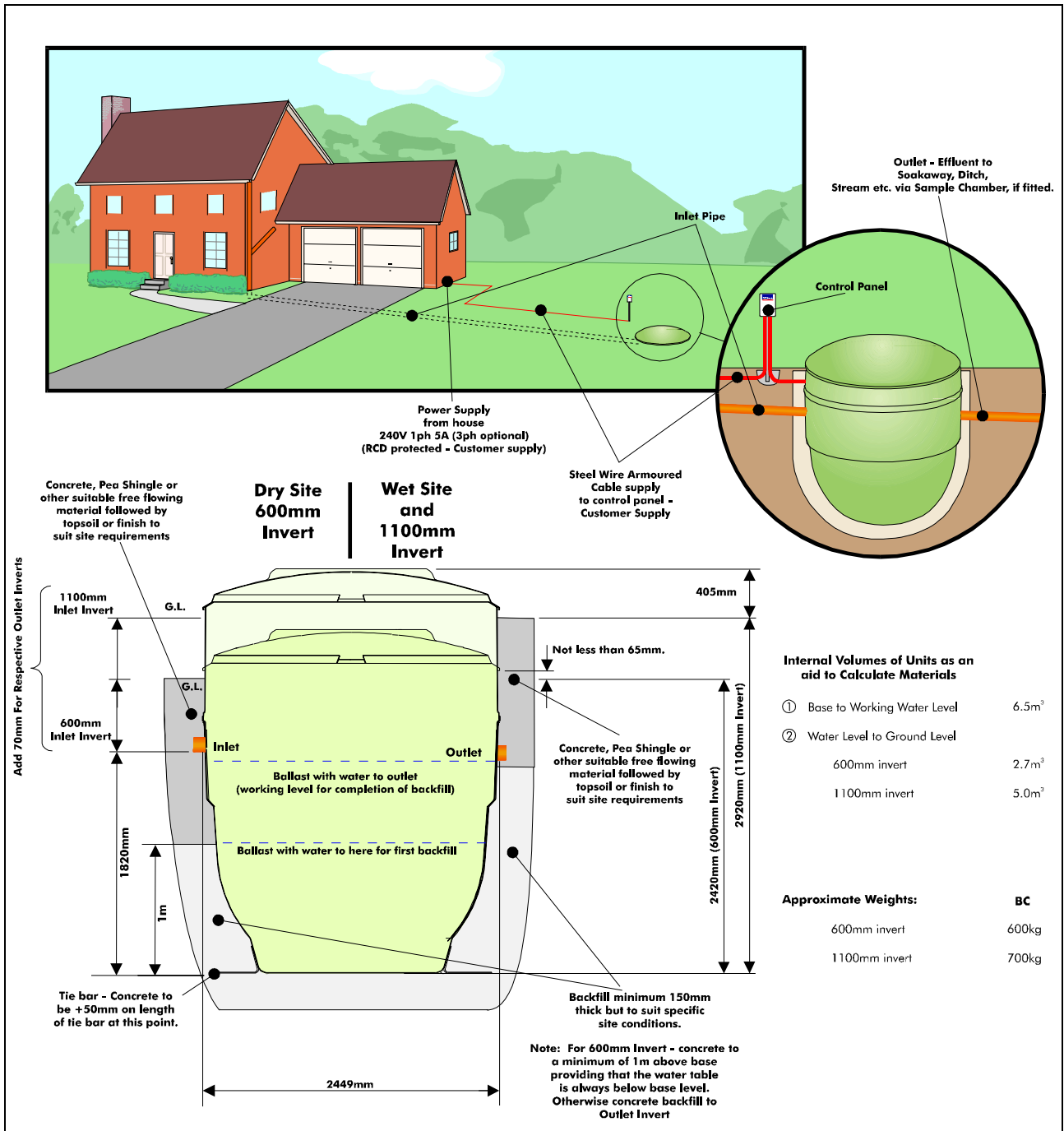

2.4.3 Connect the inlet and outlet pipework when safe access can be gained. Short lengths of “rocker” pipe with flexible joints should be used adjacent to the unit to allow for any minor differential movement.

GL0013K – Installation Guidelines for BioDisc BC & NC

- 2.4.4 Check the cables attached to the Control Panel and drill the corresponding number of 40mm holes in the BioDisc case, 100mm below ground level and adjacent to one end of the baffle supporting the Motor/gearbox. If an Independent Remote Alarm is to be fitted this will also require a 40mm hole.
- 2.4.5 Erect the Control Panel as described in Section 3.
- 2.4.6 Continue to backfill, with concrete or free flowing granular material, up to ground level. The finished surface should be 65mm minimum lower than the lip of the cover.
- 2.4.7 Important : Read section 5.1.3 regarding delayed electrical installation.

3 Control Panel Installation

3.1 General Installation

- 3.1.1 The control panel need not be adjacent to the plant. It can be wall mounted or fixed to the mounting frame (available separately). It should be positioned so it cannot be reached by someone standing in or on the BioDisc unit.
- 3.1.2 The control panel should be fitted by a qualified electrician working to the latest IEE Regulations.

3.2 Mounting Frame Installation (where applicable)

- 3.2.1 Set the frame legs in a concrete base, minimum 250mm thick and prop the frame to prevent movement until the concrete has set.
- 3.2.2 Allow 350mm minimum clearance from finished ground level to the bottom of the panel.

3.3 Installation of Control Panel

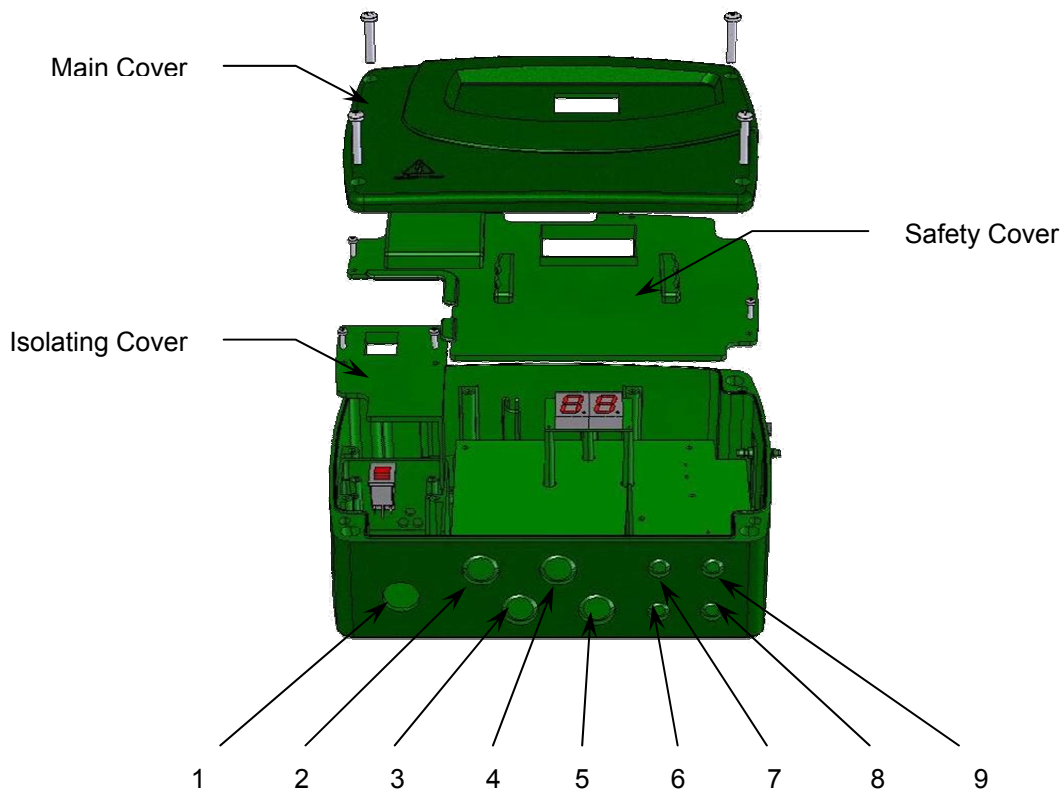



Figure 1 : Control Panel Gland Holes



- 3.3.1 Remove the four screws on the front of the panel and remove the main cover.
- 3.3.2 Remove the four screws holding the safety cover and remove the safety cover.
- 3.3.3 Remove the two screws holding the isolating cover and remove the isolating cover.
- 3.3.4 Using a suitable M20 gland, feed the mains power supply through Gland Hole 1 (Figure 1). Wire the mains supply to the terminal blocks following the guide on the connections.
- 3.3.5 Replace the isolation cover and screws.

GL0013K – Installation Guidelines for BioDisc BC & NC

- 3.3.6 Using a suitable M20 gland, feed the motor power supply cable through Gland Hole 4 (Figure 1) and terminate to connections 5 & 6 (TB3) following the guide on Table 2. 
- 3.3.7 Connect the other end of the motor power supply cable to the junction box in the plant (marked MOTOR).

Terminal Block Number	1, 3, 5 & 7	2, 4, 6 & 8	
Connection	Live - Red	Neutral - Black	Earth – Green/Yellow
Terminal Block Number	11	12	
Connection	Brown	Grey	
Terminal Block Number	13	14	15
Connection	Common	High	Low
Terminal Block Number	16	17	18
Connection	Red	White	Black

Table 2 : Control Panel Termination Information

- 3.4 Installation of Integral Discharge Pump (where applicable)** 
- 3.4.1 Using a suitable M20 gland, feed the integral discharge pump power cable through Gland Hole 2 (Figure 1) and terminate to connections 1 & 2 (TB1) following the guide on Table 2.
- 3.5 Installation of Sludge Return Pump (where applicable)** 
- 3.5.1 Using a suitable M20 gland, feed the integral discharge pump power cable through Gland Hole 3 (Figure 1) and terminate to connection 3 & 4 (TB2) following the guide on Table 2.
- 3.5.2 Set the run and pause times for the sludge return pump as described in Table 3.

Sludge Return Pump Pause Time		
Switch 5	Switch 6	
Off	Off	12 hours
Off	On	6 hours
On	Off	2 hours (default)
On	On	1 hour
Sludge Return Pump On Time		
Switch 7	Switch 8	
Off	Off	30 seconds
Off	On	20 seconds (default)
On	Off	10 seconds
On	On	5 seconds

Table 3 : Sludge Return Pump Settings

3.6 Installation of Chemical Dosing System (where applicable)



- 3.6.1 Using a suitable M20 gland, feed the chemical dosing pump power cable through Gland Hole 5 (Figure 1) and terminate to connections 7 & 8 (TB4) following the guide on Table 2.
- 3.6.2 Using a suitable M12 gland, feed the chemical dosing probe cable through Gland Hole 8 (Figure 1) and terminate to connections 13, 14 & 15 (TB7) following the guide on Table 2.
- 3.6.3 Connect the other end of the chemical dosing pump power supply cable to the junction box in the plant (marked CHEMICAL DOSING).
- 3.6.4 Connect the other end of the chemical dosing probe cable to the junction box in the plant (marked CHEMICAL DOSING).
- 3.6.5 Set the run and pause times for the chemical dosing pump as described in Table 4.

Chemical Dosing Pump Pause Time		
Switch 1	Switch 2	
Off	Off	25 minutes
Off	On	12 minutes (default)
On	Off	6 minutes
On	On	3 minutes
Chemical Dosing Pump On Time		
Switch 3	Switch 4	
Off	Off	4 seconds
Off	On	3 seconds (default)
On	Off	2 seconds
On	On	1 second

Table 4 : Chemical Dosing Pump Settings

- 3.6.6 Using a small screwdriver, push switch 12 to the ON position.

3.7 Installation of Loss of Rotation Alarm (where applicable)



- 3.7.1 Using a suitable M12 gland, feed the loss of rotation alarm cable through Gland Hole 6 (Figure 1) and terminate to connection 9 & 10 (TB5). The two contacts are not position sensitive.
- 3.7.2 Connect the other end of the loss of rotation alarm cable to the junction box in the plant (marked LOR).
- 3.7.3 Using a small screwdriver, push switch 10 to the ON position.

3.8 Installation of High Level Alarm (where applicable)



- 3.8.1 Remove the link in the terminal blocks between connections 11 & 12 (TB6) before inserting cables. Using a suitable M12 gland, feed the high level alarm float cable through Gland Hole 7 (Figure 1) and terminate to connection 11 & 12 (TB6) following the guide on Table 2.
- 3.8.2 Fix the bracket attached to the float to the steelwork supporting the motor using the two free holes.
- 3.8.3 Ensure that the base of the float is 300mm from the bracket when held horizontally.

3.9 Installation of Beacon (where applicable)



- 3.9.1 The beacon can be mounted up to 30m from the panel. The beacon is intended to be mounted on a wall or other solid surface.
- 3.9.2 Using a suitable M12 gland, feed the cable from the beacon through Gland Hole 9 (Figure 1) and terminate to connection 16, 17 & 18 (TB8) following the guide on Table 2.

3.10 Completing the Installation

- 3.10.1 Plug the lead from the battery into the small white socket in the top right corner of the PCB marked "BATTERY HEADER".
- 3.10.2 The display should now show "F1". This is normal and is indicating that there is no mains power to the panel. At this point the panel is running from the battery power.
- 3.10.3 Replace the safety cover and screws.
- 3.10.4 Turn the mains supply on at the source.
- 3.10.5 Turn on the panel using the isolation switch. It should now be illuminated red. The display should now read "- -". Press the orange reset button next to the display to clear the display.
- 3.10.6 Replace the main cover and screws.
- 3.10.7 The unit is now fully operational.

4 Ancillary Equipment

- 4.1.1 Ancillary items should be installed in accordance with the Installation Guide supplied e.g. Crude Sewage Pump Station, Effluent Pump Station, Effluent Sample Chamber.

5 Start Up

- 5.1.1 Refer to the Owners Handbook for details of the Start Up Procedure.
- 5.1.2 We recommend the unit is commissioned by an approved engineer.
- 5.1.3 Once the unit has been installed it should be left filled with water. Please switch on the motor, following the procedure in the Owners Handbook and leave the unit running, even if there is no sewage being fed into the plant. If the unit has been installed with no operational power supply, then remove the motor/gearbox unit and store it in a dry or heated environment until such time as the unit is ready for permanent operation.